



Technology Solutions

TEK-DP 1620A

Cone Meter



FLOW



Table of Contents

1	Safety Instructions	3
1.1	Intended Use	3
1.2	Certifications	3
1.3	Safety Instructions from the Manufacturer	3
1.3.1	Disclaimer	3
1.3.2	Product Liability and Warranty	3
1.3.3	Information Concerning the Documentation	3
1.4	Safety Precautions	3
1.5	Packaging, Transportation and Storage	4
1.5.1	Packaging	4
1.5.2	Transportation	5
1.5.3	Storage	5
1.5.4	Nameplate	5
2	Product Description	6
2.1	Introduction	6
2.2	Usage and DP Applications	6
2.3	Main Meter Components	6
2.4	Measuring Principle	7
2.5	Operation	8
2.6	System Components	9
2.6.1	Differential Pressure Transmitters	9
2.6.2	Shut-Off Valves	9
2.6.3	Valve Manifolds	9
2.6.4	Impulse Tubing Considerations	10
2.6.5	Tubing Size Selection	10
2.6.6	Process Tubing / Sensing Lines	10
2.6.7	Tubing Lengths and Configurations	10
2.7	Very High Temperature Applications	11
2.8	Very Cold Temperatures	11
2.9	Best Practices for Installing the Tek-DPro Cone Meter	12
2.10	Flow Run Requirements	12
2.11	Meter Orientation and Transmitter Position	12
2.12	Pressure Tap Location	12
2.13	For horizontal installations, the following installation guidelines apply	12
2.14	Points to check for the Transmitter / Meter Installation	13
2.15	Liquid Service Meter Installation	13
2.15.1	Meter Orientation	13
2.15.2	Pipe Orientation	13
2.15.3	Wall Taps	13
2.15.4	Condensate Chamber or Drip Pot	14
2.15.5	Horizontal Installation for Liquids	14
2.15.6	Vertical Installation for liquids	14
2.15.7	Horizontal Meter Installation for Wet Gas	15
2.16	Cone Meter Installation - Hot Gases / Steam	16
2.16.1	Orientation	16
2.16.2	Sensing /Impulse Tubing Orientation	16

2.16.3	Condensate Chambers.....	16
2.16.4	Horizontal Service Applications – Steam / Hot Gases	16
2.17	Specifications.....	17
2.18	Transmitters or Flow Computers.....	18
2.19	Cone Meter Designs	18
2.20	Process Connections	19
2.21	Dimensional Drawings	19
2.22	Model Charts	22
3	Installations	25
3.1	General Instructions.....	25
3.1.1	Before installing a Tek-DP 1620A Cone Meter, review the following installation tips:	25
3.2	Installation for Gases	25
3.2.1	Horizontal Installation Gases.....	25
3.2.2	Vertical Installation Gases	26
3.3	Installation for Liquids	27
3.3.1	Horizontal Installations Liquids	27
3.3.2	Vertical Installations Liquids	27
3.4	Installations for Steam	29
3.4.1	Horizontal Installation for Steam.....	29
3.4.2	Vertical Installation for Steam	29
3.5	Installation for Upstream and Downstream.....	30
4	Maintenance	31
5	Troubleshooting.....	32

1 Safety Instructions

1.1 Intended Use

Tek-DP 1620A Cone Meter is measures flow over a wide range of Reynolds numbers of gas, steam and liquid applications.

1.2 Certifications

ISO 5167-5 Compliance.

1.3 Safety Instructions from the Manufacturer

1.3.1 Disclaimer

The manufacturer will not be held accountable for any damage that happens by using its product, including, but not limited to direct, indirect, or incidental and consequential damages.

Any product purchased from the manufacturer is warranted in accordance with the relevant product documentation and our Terms and Conditions of Sale.

The manufacturer has the right to modify the content of this document, including the disclaimer, at any time for any reason without prior notice, and will not be answerable in any way for the possible consequence of such changes.

1.3.2 Product Liability and Warranty

The operator shall bear authority for the suitability of the device for the specific application. The manufacturer accepts no liability for the consequences of misuse by the operator. Wrong installation or operation of the devices (systems) will cause the warranty to be void. The respective Terms and Conditions of Sale, which forms the basis for the sales contract shall also apply.

1.3.3 Information Concerning the Documentation

To prevent any injury to the operator or damage to the device it is essential to read the information in this document and the applicable national standard safety instructions. This operating manual contain all the information that is required in various stages, such as product identification, incoming acceptance and storage, mounting, connection, operation and commissioning, troubleshooting, maintenance, and disposal.

1.4 Safety Precautions

You must read these instructions carefully prior to installing and commissioning the device. These instructions are an important part of the product and must be kept for future reference. Only by observing these instructions, optimum protection of both personnel and the environment, as well as safe and fault-free operation of the device can be ensured.

For additional information that are not discussed in this manual, contact the manufacturer.

Warnings and Symbols Used

The following safety symbol marks are used in this operation manual and on the instrument.



WARNING

Indicates a potentially hazardous situation which, if not avoided, could result in death or severe injury



CAUTION

Indicates a potentially hazardous situation which, if not avoided, may result in minor or moderate injury. It may also be used to alert against unsafe practices.



NOTE

Indicates that operating the hardware or software in this manner may damage it or lead to system failure.

1.5 Packaging, Transportation and Storage

1.5.1 Packaging

The original package consists of

1. Tek-DP 1620A Cone Meter
2. Documentation Package NDT and Materials Certificates



1



2

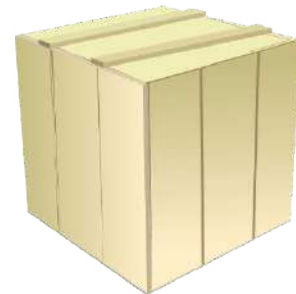

NOTE

Unpack and Check the contents for damages or sign of rough handling. Report damage to the manufacturer immediately. Check the contents against the packing list provided.

1.5.2 Transportation

- Avoid impact shocks to the device and prevent it from getting wet during transportation.
- Verify local safety regulations, directives, and company procedures with respect to hoisting, rigging, and transportation of heavy equipment.
- Transport the product to the installation site using the original manufacturer's packing whenever possible.

1.5.3 Storage

If this product is to be stored for a long period of time before installation, take the following precautions:

- Store your product in the manufacturer's original packing used for shipping.
- Storage location should conform to the following requirements:
 1. Free from rain and water ingress
 2. Free from vibration and impact shock
 3. At room temperature with minimal temperature and humidity variation
- Properties of the instrument can change when stored outdoors (carbon steels).

1.5.4 Nameplate

The nameplate lists the order number and other important information, such as design details and technical data.

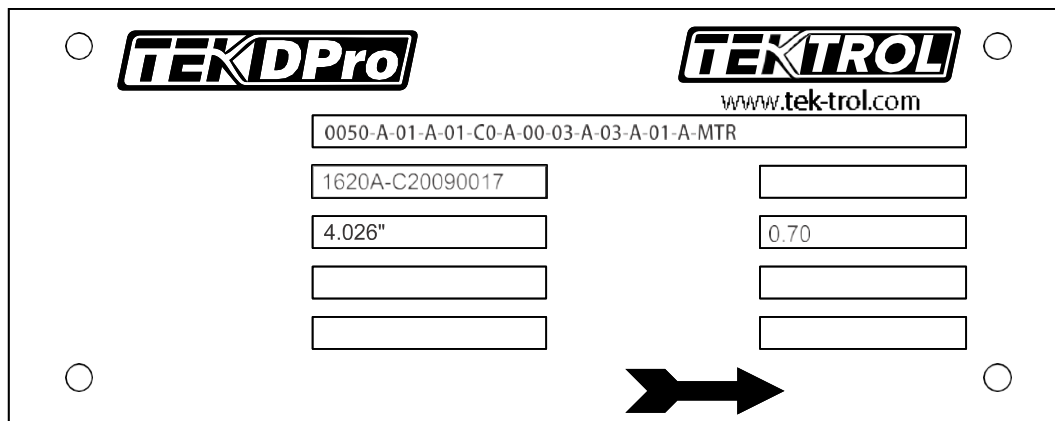

i NOTE

Check the device nameplate to ensure that the device is delivered according to your order. Check for the correct Beta Ratio, Pipe ID, and TAG number if printed on the nameplate. Flow Meter Coefficient of discharge (C_d) is shown on the materials certification / documentation for entry into a flow computer

2 Product Description

2.1 Introduction

Tek-DP 1620A Cone Meters are manufactured and designed for measuring multiple fluid types from gases to liquids and vapors, the meter uses differential pressure to provide accurate, repeatable and low cost of ownership measurement solutions.

All Tek-DP 1620A Cone Meters read flow rates by using by a differential pressure or multi-variable transmitter in conjunction with a flow computer in certain world regions chart recorders are still used which will operate with a cone meter.

The method used to connect the transmitter to the meter varies, depending on the type of product measured and available space for mounting the meter in the supporting pipework. This operator manual provides installation instructions and some piping diagrams for using the Cone Meter in liquid, gas, and steam applications.

2.2 Usage and DP Applications

Tek-DP 1620A Cone Meters are fully capable and designed to work in both unprocessed and processed applications, and are ideal for upstream, midstream and downstream flow measurement applications that present large measurement challenges.

The Tek-DP 1620A Cone Meters is also available in many different configurations for low-pressure coalbed/seam methane wellhead, High /low pressure separator, wet gas with Tek DPro validation systems steam and other field applications, compressor anti-surge control, and fuel gas as detailed within the company website.

2.3 Main Meter Components

The cone meter comprises three main components, as shown in Figure 1 & Figure 2.

- i. Meter body or tube (closed conduit) with or without flanges
- ii. Differential Pressure Cone assembly, either fabricated or machined from a mono-block stainless/ other steel piece (not carbon) positioned in the center of the meter tube
- iii. A pair of pressure tapping's - wall tap upstream and a sensing tap downstream with a pressure sensing conduit for reading differential pressures at the center of the cone and meter body. (Note: a downstream wall-tap may be used under certain process measurement conditions.)

All Tek-DP 1620A Cone Meters can be manufactured from various materials (Carbon-A105/106/LF350 steels etc., stainless, or duplex stainless steel) to meet specific process requirements for metering: natural gas steam, air, nitrogen, ethanol, digester gas and a host of hydrocarbon and non-Hydrocarbon liquids from crude oil to wastewater and cryogenic products. The Tek-DP 1620A Cone Meter is manufactured to meet the ISO 5167 Part 5 DP Cone Meter Standard when applied for custody transfer applications the same dimensions and geometry is used for other cone meter types with certain exceptions such as wall taps for vertical flow orientations and extra taps for smart metering operations.

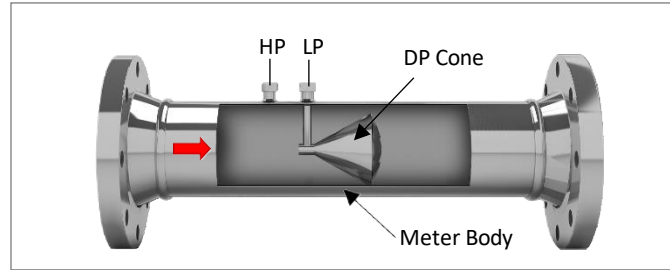

Fig 1: Basic components of the Tek-DP 1620A Cone Meter

The Tek-DP 1620A Cone Meter has no moving parts, and is designed to ISO 5167 Part 5 Geometries. There are no stagnation areas at the DP meter element where trash or fluid particles can lodge within the measurement section during normal flowing conditions.

The meter is virtually maintenance-free due to the self-cleaning action at the cone beta edge which resides downstream of the flow.

2.4 Measuring Principle

The Tek-DP 1620A Cone Meter generates a differential pressure across a centrally fixed cone shape that can be used to calculate fluid flow rates using ISO 5167 Part 5 published equations.

A DP / MVT transmitter measures the differential pressure and outputs an integrated electronic signal, typically via standard Modbus or a 4-20 mA output to a flow measurement computer with cone meter equations installed, or other process control tertiary device for readout and review. For compressible fluids (gasses), line pressure and temperature measurements are required for accurate flow rate calculations such as custody transfer applications as well as compensation for any adiabatic changes in the meter expansion factor also detailed in ISO 5167 Part 5. During normal operation process fluids flow around the differential producer cone, and pressure drop occurs according to Bernoulli principles of conservation of energy. The static line pressure (P1) is measured via a wall tap strategically located upstream of the cone (Figure 2). Pressure is also measured via a sensing tap that is connected to the cone center using a conduit and measures pressure at a central point immediately downstream of the cone (P2). The fluid flow-rate is calculated using the differential pressure (DP).

The principle of the conservation of mass and energy applies to cone meters thus, a flow rate Q is proportional to the Square Root of the DP. The pipe area is based on the internal pipe diameter and the area reduction being the annulus area at the cone beta edge. This relationship is called the beta ratio (β) for DP Cone Meters this is calculated as being:

$$\beta = \sqrt{1 - \frac{d^2}{D^2}}$$

Where, D is pipe Diameter.
d is Cone Diameter.

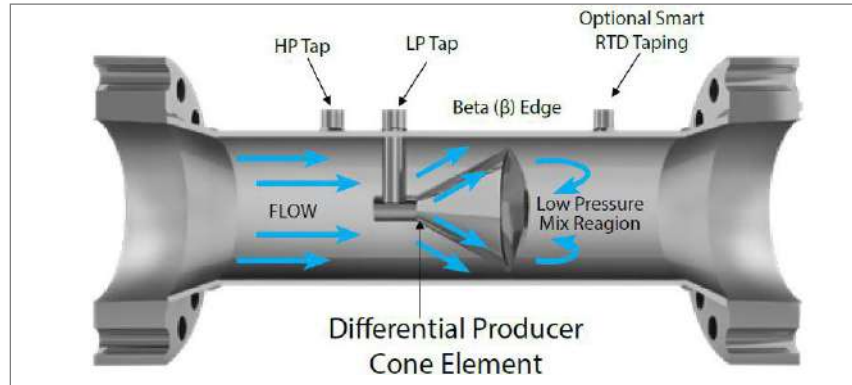

Fig 2: TEK-DP 1620A DP Cone Meter (Cutaway View – Flow Streams)

The meter differential producer cone element reshapes the fluid velocity profile directly upstream and across the expanding element conditioning flows naturally and eliminating the need for traditional flow conditioners or long straight lengths. Tek-DP 1620A Cone Meter can therefore be installed in shorter meter runs than those required by a conventional differential pressure meter and high degrees of performance are ensured even under extremely disturbed flow conditions.

2.5 Operation

All Tek-DPro DP Cone Meters are fabricated and assembled using ASME approved welding techniques. Welder qualifications and material certification available to 3.lb and 3.lc quality requirements with full material traceability either in standard steels or exotics.

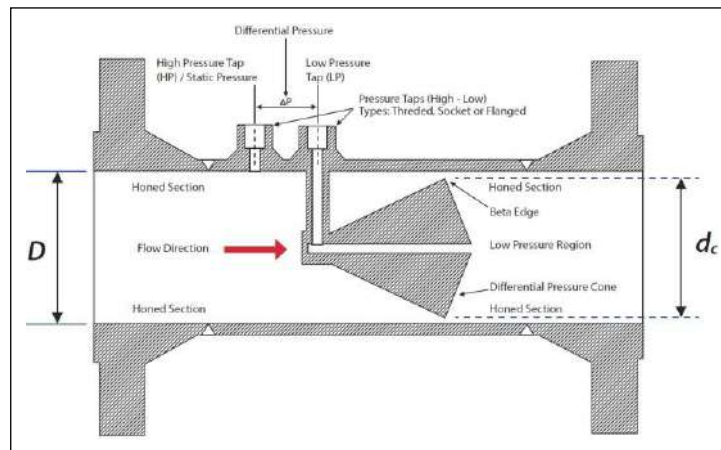

Fig 3: TEK-DP 1620A DP Cone Meter

TEK-DPro Cone Meters are manufactured with attention to their geometry and metrology based on ISO Standards. All up and downstream weld-neck seam welds are honed to provide smooth entry & exit into and out of the cone meter measurement section.

This honing procedure minimizes fluid jetting effects entering the meter throat/annulus that may occur at certain higher fluid Re_D numbers.



NOTE

Jetting effects occur where weld beads protrude into the flow stream and may cause an over-run of the flow conditioning effect provided by the meter DP element. This effect is particularly evident on larger beta ratios, it is good practice to always implement this operation in the manufacturing process of a cone meter

2.6 System Components

A transmitter, valve manifold, shut-off valves, and impulse tubing are typically required for the operation of a Tek-DP 1620A Cone Meter. If the meter is used to measure steam, a condensate pot may also be required.

2.6.1 Differential Pressure Transmitters

A differential pressure transmitter records the differential pressure signal generated by the cone meter and provides an analog or serial output to a flow computer or data control system. The transmitter(s) selected for an installation must be appropriate for operating conditions of the process in terms of both accuracy and safety. DP devices must be zeroed following installation. The procedure varies somewhat for liquid, gas, and steam applications.

2.6.2 Shut-Off Valves

Choose a block valve that is rated for the operating pressure of the pipe in which it will be installed. Where dangerous or corrosive fluids or gases like oxygen are likely, the block valve and packing must provide ample protection.



NOTE

The valves must not affect the transmission of the differential pressure signal.

Install block valves next to the Tek-DP 1620A Cone Meter pressure taps. Never use a globe valve for differential pressure transmission lines. (See: Figure 4)

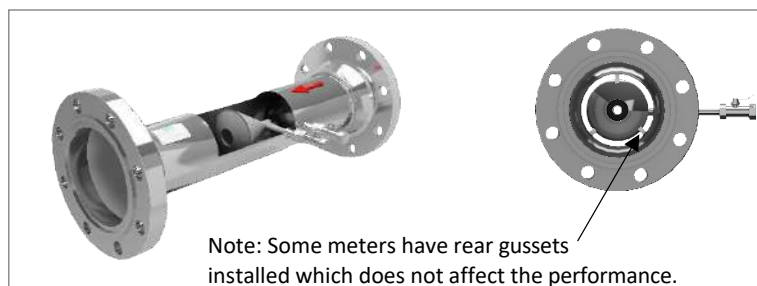

Fig 4: Valve Connections

2.6.3 Valve Manifolds

A 3-way or 5-way valve manifold isolates the transmitter from the process lines (5-valve manifolds are recommended). They allow the operator to calibrate the transmitter without removing it from the impulse tubing, drain the transmitter and impulse tubing or vent it to atmosphere. (See Figure 5)



Fig 5: Valve Manifolds



NOTE

Valve manifolds must be oriented according to manufacturer's instructions to prevent trapping of air or liquid in the sensing lines and tubing. This can cause an incorrect flow measurement condition.

2.6.4 Impulse Tubing Considerations

Before connecting impulse tubing between the Tek-DP 1620A Cone Meter and its transmitter, consider the following installation advice for optimizing your system's measurement accuracy. "In a well- designed installation, fluids will drain freely from the process lines and gases will vent to the atmosphere".

2.6.5 Tubing Size Selection.

Impulse tubing that connects any Tek-DP 1620A Cone Meter tap holes to the transmitter have diameters that change with service conditions. The bore should be no smaller than ¼" (6 mm) a minimum diameter of 3/8" (10 mm) is recommended to allow for any condensate drainage and also reduce plugging / freezing.

2.6.6 Process Tubing / Sensing Lines

The internal diameter (ID) must not exceed 1" (25 mm). For steam applications, the ID should be in the range 3/8" (10 mm) to 1" (25 mm) depending on meter diameter. The use of incorrect tubing both diameter and material selection can create a safety risk and the cost incurred to regaining a process system control can be substantial. High reliability is required for flow signals used in process safety management. A minimum tubing ID of 5/8" (16 mm) is recommended for these types of industrial applications were possible. For high temperatures in condensing vapor service, 1" (25 mm) is preferred.

2.6.7 Tubing Lengths and Configurations

For best performance, please try to meet the following recommendations for tubing length and tubing orientation:

- Tubing lengths must be short enough to ensure a high degree of accuracy, and long enough to ensure proper cooling of high-temperature fluids before they reach the transmitter.
- Make sure the installation permits access to impulse tubes, valves, valve manifolds, and transmitters in case of maintenance and also emergency maintenance.

- Limit the number of fittings and avoid long tubing sections, which can impair measurement accuracy and increase the risk of plugging.
- Avoid changes in tubing elevation and fluid temperature if possible. Differences in elevation will cause differences in hydrostatic pressure of liquid columns in process/sensing lines.
- Temperature differences may cause a difference between the density of the fluids in the two sensing lines, which will change the amount of differential pressure measured. Both can result in inaccurate differential pressure measurements. Fasten both process lines together, if possible, to alleviate this type of issue.
- Install process lines so that they slope in only one direction (up or down). If piping must be installed to slope in more than one direction, do not allow more than one bend and install a liquid or gas trap, as applicable. A liquid trap should be installed at the lowest point in a gas service installation. A gas trap should be installed at the highest point in a liquid service installation.

2.7 Very High Temperature Applications

Steam vapor can reach 1500°F (815°C), which exceeds the temperature rating of standard DP and pressure transmitters (200°F or 92°C Max). A condensate chamber / vessel can be used to isolate the transmitter from extreme temperature effects. Alternatively, a long tube section can be installed to allow the fluid to cool sufficiently before it reaches the transmitter.

As a general operational guideline when planning tubing lengths for temperature control, run a horizontal tubing orientation where possible, and allow for a temperature drop of 100°F (37.8°C) per foot (305 mm) of tubing.



NOTE

This is a rule of thumb guideline, the operator is still responsible for verification that the temperature at the transmitter does not exceed the transmitter's thermal rating including the environmental conditions during operation.

2.8 Very Cold Temperatures

During cold temperature installations, thermal insulation and/or “heat tracing” of process lines may be necessary this is required where liquids are present or the possibility of liquid drop out in a gas stream that sustains a freeze temperature to cause the liquid to solidify and block the sensing line. The amount of heat used to prevent these issues must be calculated carefully to also prevent liquids from vaporizing and prevent condensable vapors from producing unwanted condensation dual phase conditions. Fastening process lines together is highly recommended to help keep process lines approximately at the same temperature. Providing temperature-controlled environmental conditions for the transmitter also helps to ensure accurate metering in locations where extreme temperature swings are likely (i.e., offshore platforms, desert installations or artic circle regions).

2.9 Best Practices for Installing the Tek-DPro Cone Meter



WARNING

Read the best practice recommendations below in their entirety before installation of the Tek-DPro Cone Meter.

The basic steps for installing a Tek-DPro DP Cone Meter system are described as follows.

1. Install the meter in the meter run in accordance with the flow run requirements below.
2. Secure the manifold to the meter taps.
3. Connect the differential pressure transmitter to the manifold, observing the recommended guidelines below for pressure measuring tubes.
4. Connect the transmitter to the flow computer according to instructions in the transmitter user manual.
5. Zero the transmitter.

2.10 Flow Run Requirements

The Tek-DPro Cone Meter should be installed with zero to five pipe diameters of straight run upstream of the meter and zero to three pipe diameters downstream. The meter can be used in pipelines that are slightly larger than the meter tube; however, if the meter tube is larger than the pipeline, operators should contact Tek-DPro for installation requirements. This is usually determined before supply according to application and the degree of accuracy and performance required.

2.11 Meter Orientation and Transmitter Position

The Tek-DPro Cone Meter can be installed in a horizontal or vertical position. The location of the transmitter with respect to the meter should be based on the properties of the fluid or gas being measured (gas, steam, liquid, etc.) and the direction of flow through the pipeline.

The direction of flow is clearly labeled on nameplate affixed to the body of every Tek-DPro Cone Meter shipped. The meter must be installed so that the static pressure is always upstream of the differential pressure tap.

2.12 Pressure Tap Location

Location of the static pressure and differential pressure taps will vary with the product flowing through the pipeline (liquid, gas, or steam) and the orientation of the meter (vertical or horizontal).

2.13 For horizontal installations, the following installation guidelines apply:

- For measuring liquid, differential pressure taps should be located in the bottom half of the pipeline, between 4 o'clock and 5 o'clock positions, or between 7 o'clock and 8 o'clock positions.
- For measuring gas, differential pressure taps should be located in the top half of the pipeline. For wet gas, taps should be located between the 10 o'clock and 2 o'clock positions to allow proper drainage of liquids present.
- For steam, differential pressure taps should be located in the side of the pipeline.

Illustrations of typical piping configurations for liquid, gas, and steam are provided in figure 6.

For additional installation information, refer to ISO 5167 various parts (part 5 cone meters) or contact Tek-Trol etc.

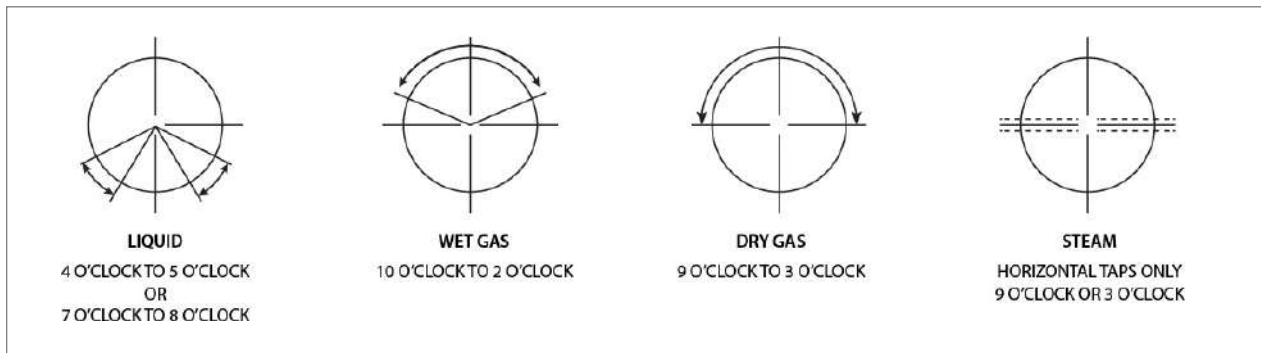

Fig 6. Standard Port Location for Horizontal Installation

2.14 Points to check for the Transmitter / Meter Installation

Before putting the Tek-DPro Cone Meter into service, verify that the transmitter is installed properly by reviewing the following checkpoints:

- Is the transmitter full scale range correct?
- Has the transmitter zero been checked and/or adjusted (dead weight tested)?
- Has the transmitter and flow computer been set to the correct operating mode "linear or square root"?
- Have the sensing lines to the transmitter been purged cleaned / blown with nitrogen?
- Are there any leaks in the sensing lines?
- Is the manifold calibration cross valve closed?
- Is the Tek-DPro Cone Meter high pressure port located upstream of the low-pressure port and connected the correct way to the transmitter – negative flow may show if incorrectly mounted?

2.15 Liquid Service Meter Installation

2.15.1 Meter Orientation

Tek-DPro Cone Meters can be installed both in a horizontal or vertical position.

Horizontal Installations are the standard orientation, however where space is very limited, a vertical position may prove to be the best option.

2.15.2 Pipe Orientation

The orientation of piping is dictated by the position of the meter, the type of product being measured, and for vertical meter installations, the direction of flow. When a vertical piping system is used, the operator must give special consideration to the piping configuration to prevent gas from being trapped in liquid differential pressure lines.

2.15.3 Wall Taps

In extremely cold environments where there is a risk of product freezing in the process lines, the low-pressure sensing port connected to the cone meter can become plugged with ice for such installations, a downstream wall tap may be installed in the meter and should be used measure the downstream differential pressure value. (Note this has to be installed during manufacturing and selected as an option before supply).

This option will allow ice /hydrate blockage to be removed without removing the meter from the meter run, but the meter run must be isolated and depressurized before attempting to clean out the blockage refer to earlier sections regarding this aspect.

2.15.4 Condensate Chamber or Drip Pot

Condensate chamber (drip pot) is a collection vessel recommended in certain standards to avoid gas bubbles in liquid instrument tubing. It should be mounted at the highest point in the impulse tubing between the cone meter and the DP transmitter.

2.15.5 Horizontal Installation for Liquids

For horizontal installations, pressure taps must be positioned at 30° to 60° below the horizontal centerline (4 o'clock to 5 o'clock or 7 o'clock to 8 o'clock). Taps at the bottom of the pipe may also become plugged with solids from the liquid; taps above the centerline can accumulate air locks or non-condensing gases. For liquid service, the connecting sensing lines from the meter to the transmitter shall slope downward towards the transmitter with no U bends or opportunities for pockets. The minimum recommended slope for self-venting is 1 inch per foot as from various national standards documentation.

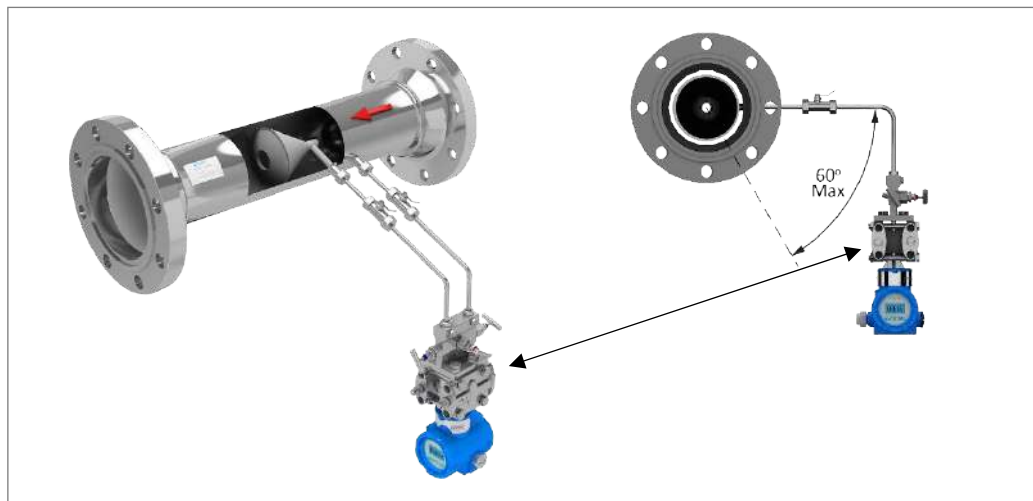

Fig 7. Installation - Liquid measurement (Horizontal Cone Meter)

2.15.6 Vertical Installation for liquids

In most process applications, the operator should assume that some level of gas or vapor exists in a liquid service, even if the liquid is water. As a result, the piping configuration must be designed to allow gas to rise back into the flow stream. The process piping should be extended horizontally a very short distance from the downstream tap and then sloped at a nominal 1-inch-per-foot angle to the top of the manifold block. The manifold block should be mounted horizontally below the upstream tap so that piping from the upstream tap to the manifold slopes downward also.



CAUTION

When a flowing condition is stopped, particulates may fall into the low-pressure port. It is advisable to flush the low-pressure port with an inert fluid before starting the meter, unless a wall tap design is being used. A wall tap design should always be used on applications where trash may have a propensity to fall into the central low-pressure port (Fig 1.0). Downward flow piping configurations that use the standard upstream and downstream pressure ports are also not recommended for liquid applications due to the risk of trapping gas. For such applications, consider the use of a vertically oriented meter with two wall taps (Fig 2.0)



Fig 8: Installation suggestion for upward flowing condition - Cone Meter with Vertical Orientation

2.15.7 Horizontal Meter Installation for Wet Gas

The pressure taps on the Tek-DPro DP Cone Meter should be between the horizontal centerline and the top of the pipe (3 o'clock to 12 o'clock or 9 o'clock to 12 o'clock). If the fluid is a "wet gas" (i.e., a gas containing small quantities of liquids). The pressure taps should be situated in a vertical position (12 o'clock) to allow all liquids to drain away from the transmitter (Figure 9). If the connecting tubing extending from the cone meter to the transmitter is not installed in a vertical position, it should slope upward (at least 1 inch per foot) to ensure proper drainage.

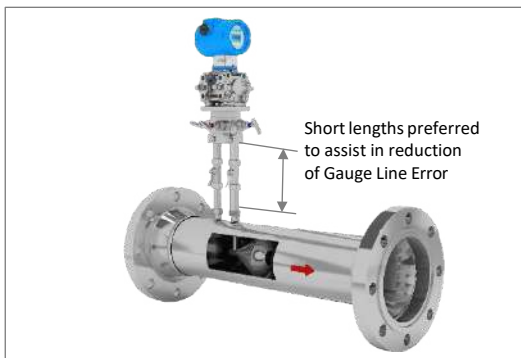

Fig 9: 12 o'clock position (preferred)

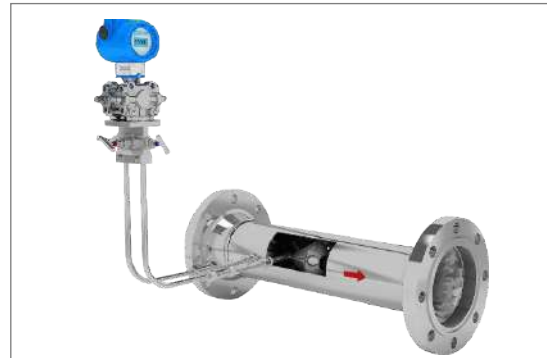

Fig 10: 3 o'clock position

2.16 Cone Meter Installation - Hot Gases / Steam

The most difficult application for a differential pressure measurement is steam or hot gasses. This installation requires careful consideration regarding the transmitter tubing. Steam /Hot Gases are usually at a temperature which can damage a DP transmitter and may not be single phase due to temperature change at the tubing due to various factors (Insulation failure, Joules Thompson effects, Phase envelope etc.) Liquid or gaseous phases can ensue depending on both temperature and pressure /environmental conditions. Differential pressure impulse tubing must be orientated in such a manner that it can operate with a gas or liquid present which requires some initial review of the intended install.

2.16.1 Orientation

All Tek-DPro Cone Meters can be installed in a horizontal or vertical position. Horizontal is the standard orientation, however where space is very limited, a vertical position may prove to be the best option taking into consideration the previous suggestions in earlier paragraphs.

2.16.2 Sensing /Impulse Tubing Orientation

The installation /position of the DP impulse tubing is determined by the orientation of the meter, also the type and quality of the Steam/Hot Gas to be measured. For vertical meter installations, the flow direction is also a factor. When a vertical meter run is to be used, operators/ system designers should give special consideration to the impulse tubing configuration to prevent liquid from being trapped and thus cause incorrect measurement readings.

2.16.3 Condensate Chambers

Condensate chambers are installed to provide a liquid reservoir / buffer that helps to prevent super-heated steam from entering a differential pressure transmitter and causing overheating of the electronics. In most cases, a large-diameter tee is only required to collect the liquid. However, if the DP is being read by using a chart recorder, a larger volume condensate chamber reservoir will be needed to prevent heat issues. Modern DP / smart transmitters have smaller diaphragm movements and do not need large condensate chamber volumes.

2.16.4 Horizontal Service Applications – Steam / Hot Gases

The meter shall be installed so that the pressure taps shall be situated above the horizontal centerline (9 o'clock to 3 o'clock only) of the meter. Condensing hot vapors from steam, cause liquid fluids to form in impulse lines. The use of a condensate chamber is mandatory to prevent hot process fluid from damaging the transmitter in this operating condition. The impulse/sensing tubing should slope upwards from the cone meter to the condensate pots. As mentioned, a condensate pot can be a tubing tee (Modern DP / smart transmitters) as shown in Figure 11 or large size condensate chambers (for higher volume devices like chart recorders) as shown in Figure 12. In either case, condensate pots should be situated at the same location / level to enable differential pressure readings that are accurate. A line from the bottom of the tee to the transmitter mounted below the tee should be filled to the point where any excess fluid can drain back into the meter to help prevent build up.

In many cases, water (condensed steam) is used for this fluid fill. However, in cold weather, the fluid must be protected from freezing as mentioned in an earlier section. The fluid fill methodology requires a careful application with heat tracing and insulation to keep it in the

liquid phase and to keep both the high-pressure and low-pressure legs of the tubing at the same temperature (maintaining the liquid fill at the same density).

A liquid leg fill fluid other than base water should be used if practical. Methanol is a possible substitute, but di-butyl phthalate is recommended by various users as a fill fluid because it is immiscible with water and remains liquid throughout a broader range of temperatures than some other fill components (i.e., -31 to 645°F)

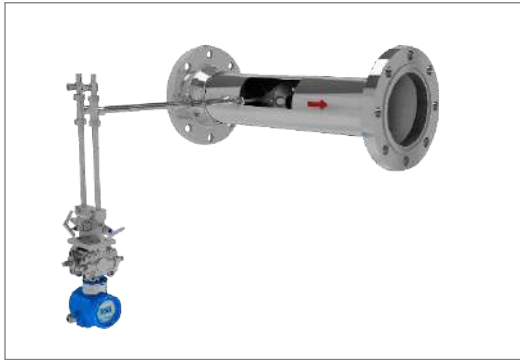

Fig 11: Horizontal Application DP Transmitter

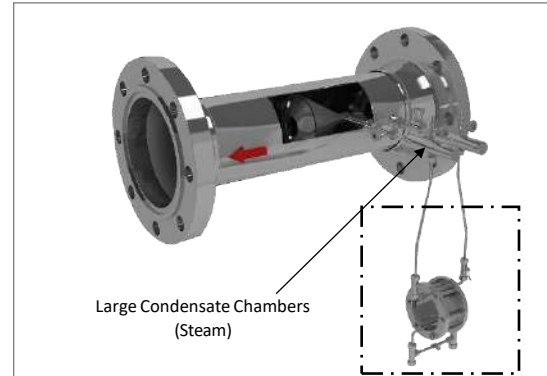

Fig 12: Horizontal Application
(Chart Recorder Typical Application)

2.17 Specifications

Accuracy	±0.5% with Calibration
Repeatability	±0.1 % or better
Flow Ranges	10:1 and greater
Standard Beta Ratios	0.45 through 0.85 Special betas available
Instillation Piping Requirements	as per ISO S167-5. Typically, 0-3D upstream and 0-2D downstream is required
Material	Inconel Duplex 304 or 316 Stainless Steel Hastelloy C-276 Carbon Steels Other materials available on request
Line Sizes	2" to 48"
End Connections	Flanged Threaded Hub or weld-end standard Others on request
Performance Verification Testing	ISO 5167-5

2.18 Transmitters or Flow Computers

- Tek-Bar 3110A Explosion Proof Differential Pressure Transmitter



Fig 13: Tek-Bar 3110A Explosion Proof Differential Pressure Transmitter

- Tek-Bar 3800E Multivariable Pressure Transmitter



Fig 14: Tek-Bar 3800E Multivariable Pressure Transmitter

- Tek-Bar 3800XH Multivariable Transmitter



Fig 15: Tek-Bar 3800XH Multivariable Transmitter

- TEK-FC 8000A Flow Computers



Fig 16: Tek-FC 8000A Flow Computer

2.19 Cone Meter Designs

- Precision Welded (Fixed Design)



Fig 17: Precision Welded

1. Field Replaceable Top Entry

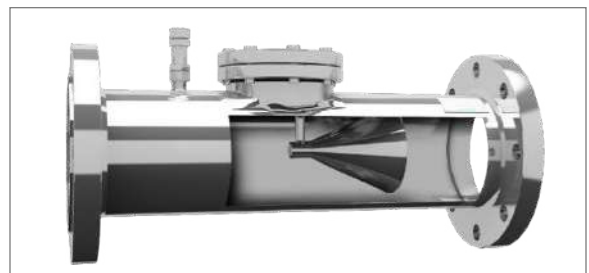

Fig 18: Field Replaceable Top Entry

- Field Replaceable Body



Fig 19: Field Replaceable Body

2.20 Process Connections

- Flange



Fig 20: Flange

- Hub

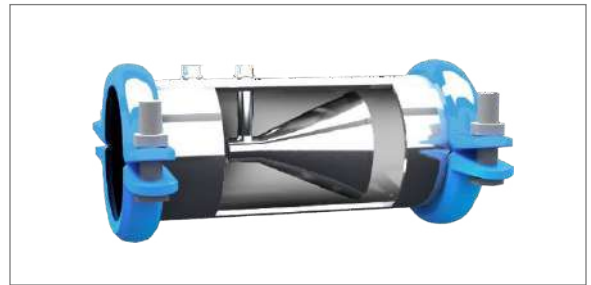

Fig 21: Hub

- Union

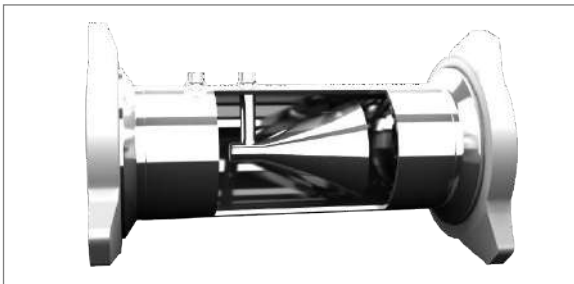

Fig 22: Union

- Wafer



Fig 23: Wafer

- Threaded

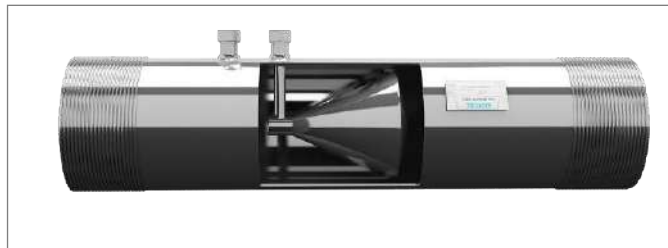

Fig 24: Threaded

2.21 Dimensional Drawings

- Beveled End

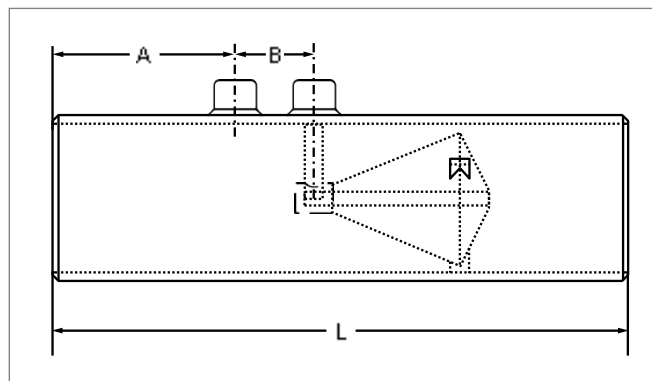

Fig 25: Beveled End

Size i-(mm)	Beveled Ends		
	Dim L in (mm)	Dim A in(mm)	Dim B in (mm)
2" (50)	9.5" (241)	4.25" (108)	2.13" (53)
3" (80)	12.5"(317)	4.25"(108)	2.13" (53)
4" (100)	15.5" (394)	3.38" (86)	2.13" (53)
6" (150)	19.25"(489)	4.13"(105)	2.13" (53)
8" (200)	23.75"(603)	5.75"(145)	2.13" (53)
10"(250)	29.75"(755)	6.25"(159)	2.13" (53)
12"(300)	35.75"(908)	6.5"(165)	2.13" (53)

- Raised-Face Slip on Flange

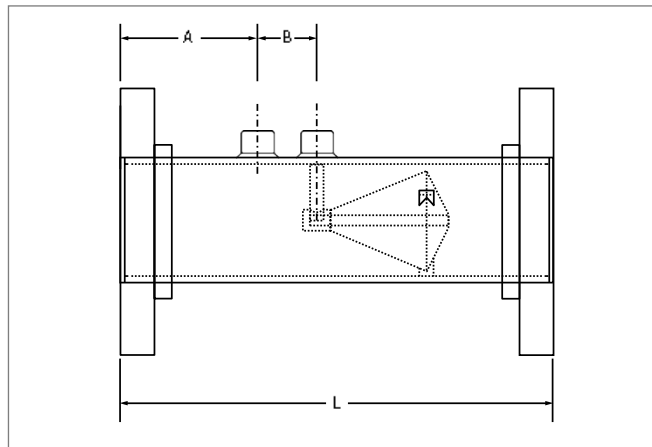

Fig 26: Raised-Face Slip on Flange

Size in inches (mm)	150# RF/ SO			300# RF/ SO			600# RF/ SO		
	L in (mm)	A in (mm)	B in (mm)	L in (mm)	A in (mm)	B in (mm)	L in (mm)	A in (mm)	B in (mm)
2" (50)	10" (254)	4.5" (112)	2.13"(53)	10" (254)	4.5" (112)	2.13"(53)	10" (254)	4.5" (112)	2.13"(53)
3" (80)	13" (322)	4.5" (112)	2.13"(53)	13" (322)	4.5" (112)	2.13"(53)	13" (322)	4.5" (112)	2.13"(53)
4" (100)	16" (400)	3.63"(92)	2.13"(53)	16" (400)	3.63"(92)	2.13"(53)	16" (400)	3.63"(92)	2.13"(53)
6" (150)	19.75" (495)	4.38"(111)	2.13"(53)	19.75" (495)	4.38"(111)	2.13"(53)	19.75" (495)	4.38"(111)	2.13"(53)
8" (200)	24" (609)	6" (152.5)	2.13"(53)	24" (609)	6" (152)	2.13"(53)	24" (609)	6" (152)	2.13"(53)
10" (250)	30" (762)	6.5"(165)	2.13"(53)	30" (762)	6.5"(165)	2.13"(53)	30" (762)	6.5"(165)	2.13"(53)
12" (300)	36" (914)	6.75"(171)	2.13"(53)	36" (914)	6.75"(165)	2.13"(53)	36" (914)	6.75"(165)	2.13"(53)

- Raised-Face Weld Neck

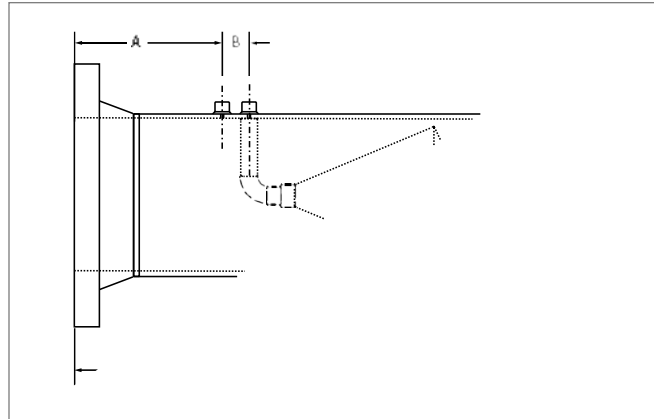

Fig 27: Raised-Face Weld Neck

Size in inches (mm)	150# RF/ SO			300# RF/ SO			600# RF/ SO		
	L in (mm)	A in (mm)	B in (mm)	L in (mm)	A in (mm)	B in (mm)	L in (mm)	A in (mm)	B in (mm)
2" (50)	14.5" (368)	6.75" (171)	2.13"(53)	15" (381)	7" (175)	2.13"(53)	15.75" (400)	7.5" (185)	2.13"(53)
3" (80)	18" (450)	7" (175)	2.13"(53)	18.75"(470)	7.25" (182)	2.13"(53)	19.5" (487)	7.75" (192)	2.13"(53)
4" (100)	21.5" (537)	6.63"(168)	2.13"(53)	22.5" (565)	6.88"(175)	2.13"(53)	25" (625)	7.13"(181)	2.13"(53)
6" (150)	26.25" (657)	7.63"(194)	2.13"(53)	27" (675)	8.13"(206)	2.13"(53)	29" (725)	9.13"(232)	2.13"(53)
8" (200)	31.5" (800)	9.75" (245)	2.13"(53)	32.25" (819)	10.25" (255)	2.13"(53)	34.5" (876)	11.25" (282)	2.13"(53)
10" (250)	37.5" (952)	10.25"(255)	2.13"(53)	38.75" (984)	10.75"(270)	2.13"(53)	42" (1067)	12.5"(312)	2.13"(53)
12" (300)	44.5" (1130)	11"(272)	2.13"(53)	45.75" (1161)	11.5"(287)	2.13"(53)	48.25" (1225)	12.75"(320)	2.13"(53)

***Note:** Dimensions are subject to vary at time of manufacturing based on final Beta selected. Dimensional drawing with a final engineering sizing sheet will be provided within 1-2 weeks of order acceptance.

2.22 Model Charts

Example	Tek-DP 1620A	0050	D	01	A	01	C0	D	00	03	A	XX	A	01	A	MTR	Tek-DP 1620A-0050-D-01-A-01-C0-D-00-03-A-XX-A-01-A
Series	Tek-DP 1620A																Cone Flow Meter
Size		0015 0020 0025 0040 0050 0065 0080 0100 0150 0200 0250 0300 0350 0400 0450 0500 0600 0700 0800 0900 1200															1/2" (only available for wafer) 3/4" (only available for wafer) 1" (only available for wafer) 1.5" 2" 2 1/2" 3" 4" 6" 8" 10" 12" 14" 16" 18" 20" 24" 28" 32" 36" 48"
Meter Body			A B C D E F G H I														Carbon Steel (Standard) Low Temp CS 304L SS 316L SS (Standard) Duplex 2205 Duplex 2507 Chromemoly CrMo P11 Chromemoly CrMo P22 Inconel Cladding Special
Pipe Schedule				01 02 03 04 05 06 07 08 09 10 11 12													STD (Standard Pipe Schedule) 10S 10 20 30 40S 40 80S 80 120 160 Extra Strong

				13 XX															XX Strong Special
Process Connection					A B C D E F G H I W U X														Raised Face Slip On Raised Face Weld Neck RTJ Slip On RTJ Weld Neck Hubs API Beveled End Socket NPTF (Up to 3") Wafer Style (Up to 4") Union Special
Pressure Rating						01 02 03 04 05 06 07 08 09 XX													150# 300# 600# 900# 1500# 2500# 3000# (NPT) 10K(API/Hubs) 15K (API/Hubs) Special
Cone Type							C0 C1 C2 W3 W												Fixed Cone Field Replaceable Body or Beta Field Replaceable Top Entry Cone Field Replaceable Cone Fixed Cone (Vertical UP Flow)
Cone Material of Construction								A B C D E F G H I											Carbon Steel Low Temp CS 304L SS 316L SS (Standard) Duplex 2205 Duplex 2507 Chromemoly CrMo P11 Chromemoly CrMo P22 Inconel Cladding Special
Tap Location									00 01 X										Cone Taps Pipe Taps Special
Pressure Taps Size										01 02 03 04 05 XX									¼" ⅜" ½" ¾" 1" Special

Pressure Tap Style	A	3000psi NPT
	B	6000psi NPT
	C	3000psi Socket
	D	6000psi Socket
	F	Flanged - Direct Mount
Beta	H	Hubs
		Valves
		Special
	01	0.45
	02	0.50
	03	0.55
	04	0.60
	05	0.65
06	0.70	
Additional Meter Taps (D/S)	07	0.75
	XX	Special
	A	None
Flow Transmitters / Computers	B	Temperature Tap (3D)
	C	Validation/Diagnostic Tap (6D)
		Special
	01	None (Customer Supplied)
	02	Tek-Bar 3110 (Liquids) - Smart DP
	03	Tek-Bar 3800 (MVT Steam and Compressed Gases)
04	Tek-FC 8000 (Natural Gas - Flow Computer)	
Calibration	05	TekValsys DPRO (Insitu Flow Validation)
	06	TekValsys DPRO WFGM (Wet Gas)
	XX	Special
	A	Dry (ISO 5167)
Options	B	Water
	C	Air
	D	Multiphase
		Special
	MTR	Material Test Report EN3.1
	MC	Material Cert EN2.1
	PMI	Positive Material Identification (NDE)
	COC	Certificate of Conformity
	HYD	Hydro Test
	XRT	X-Ray
DPT	Dye Penetrant	
MPT	Magnetic Particle Testing	
O2C	O2 Cleaned	
TAG	SS TAG PLATE	
UM	Upstream Meter Run - 1PC	
R	Downstream Meter Run - 1PC	
DMR	Meter Run with Flow Conditioner Plates - 2PC	

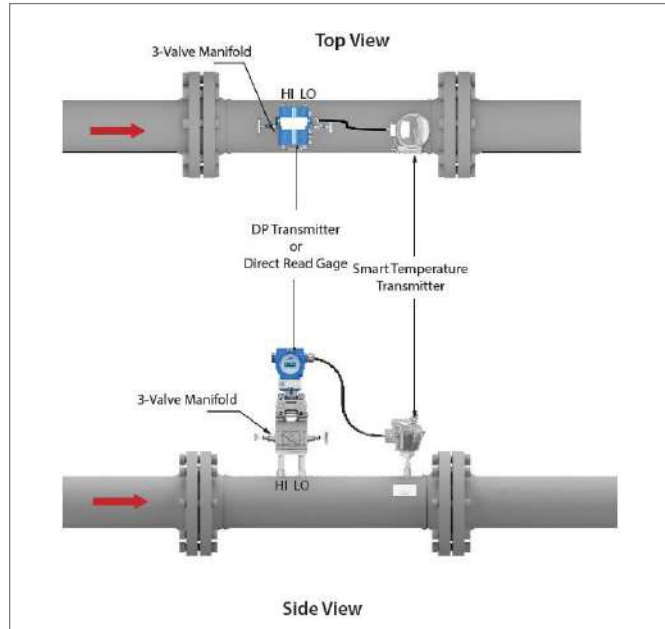

Fig 28: Horizontal Installation for Gases

3.2.2 Vertical Installation Gases

- Standard taps can be used in clean, dry, non-condensing gases, where no liquid or dirt can fill the cone.
- The position of the transmitter is not critical.
- The transmission lines should be straight to the transmitter or horizontal and then up or down to the transmitter.

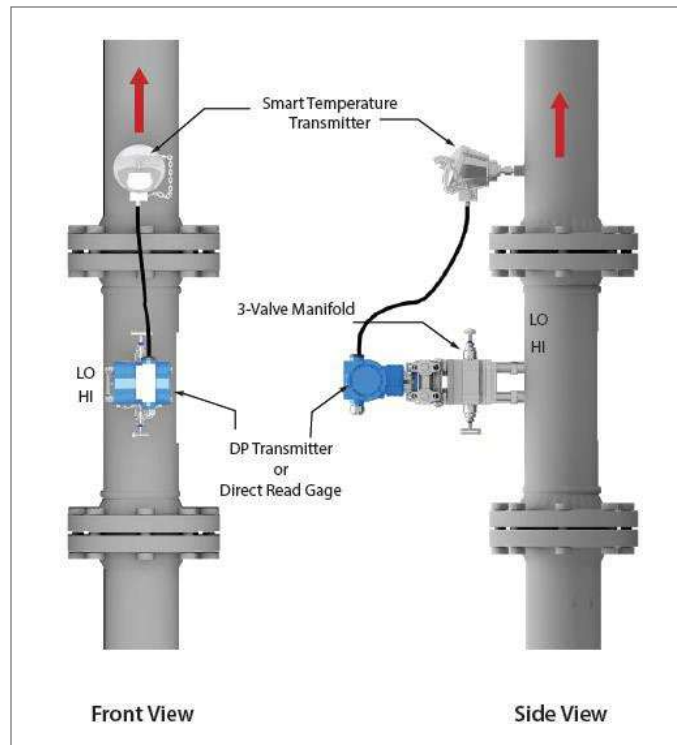

Fig 29: Vertical Installation for Gases

3.3 Installation for Liquids

3.3.1 Horizontal Installations Liquids

- The pressure taps should be between the center of the horizontal line and 60° below the centerline (3 o'clock to 5 o'clock or 7 o'clock to 9 o'clock) shown in figure 6.
- Taps at the bottom-dead-center may accumulate solids if they are present in the liquid and taps above the centerline will accumulate air or non-condensing gases.
- The taps should be more than 60° to the horizontal plane in any case.

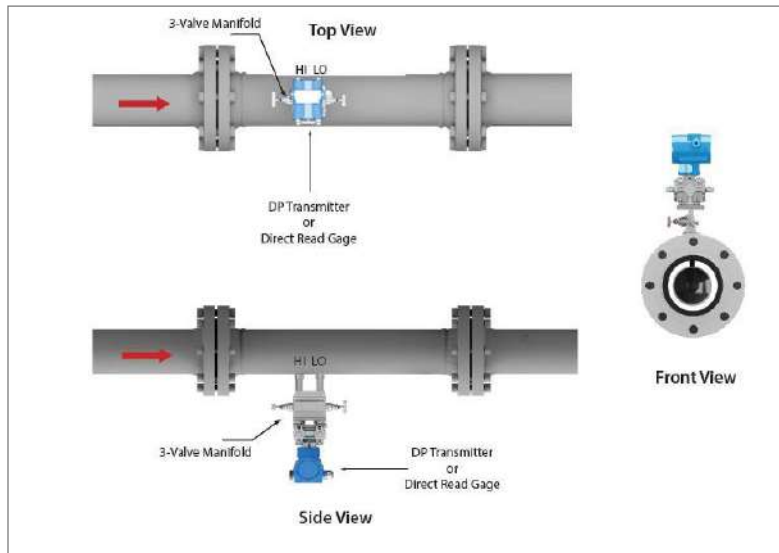

Fig 30: Horizontal Installation for Liquids

3.3.2 Vertical Installations Liquids

- In most process applications, the presumption should be made that there may be gas or vapor associated with a liquid, even though the liquid is water.
- The piping must then allow gas to rise back into the flowing medium.
- The DP piping should be carried out horizontally for a short distance and then down to the transmitter and the transmitter should be below both taps.

*Note: Wall taps must be used for dirty liquids. Standard taps should only be used on clean liquids.

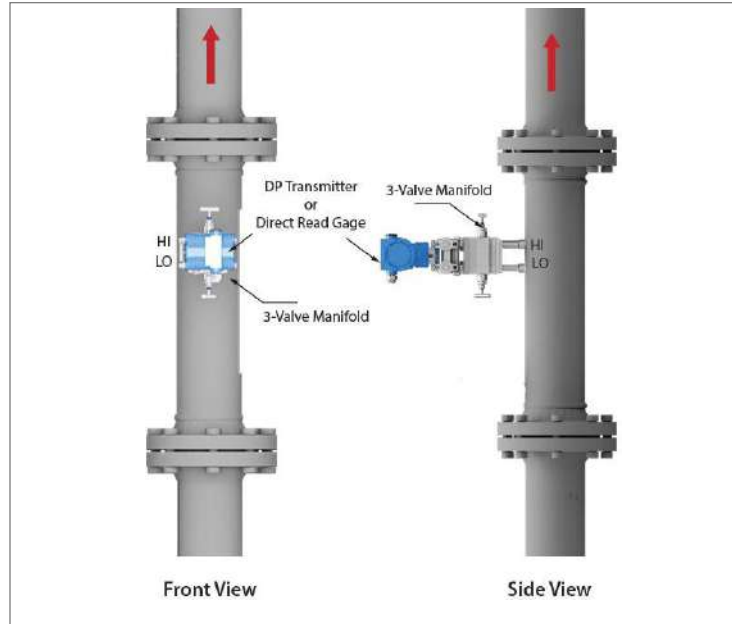

Fig 31: Vertical Installations for Liquids

3.4 Installations for Steam

3.4.1 Horizontal Installation for Steam

- Steam applications require careful consideration during installation.
- Steam at a very high temperature can damage the transmitter. Additionally, it can be in the liquid or gaseous phase, depending on temperature and pressure. Therefore, the DP pipework must be positioned in such a way that it can operate with a gas or liquid present.
- The pressure taps should be on the center of the horizontal line (3 o'clock or 9 o'clock) of the primary device. In condensing hot vapor service, such as steam, the fluid in the impulse lines is liquid condensed from the vapor. In this case, the pressure taps should be horizontal with the impulse lines and positioned to the DP transmitter, as shown in figure 31.
- There is a concern that before the lines fill with condensed liquid and cool, the secondary system will become exposed to the vapor temperature at start-up. In this case, it is wise to have a plugged tee fit in the impulse line to allow the liquid (water for steam service) to be filled with the impulse line and secondary unit before starting up (see Figure 32).
- Cryogenic (very low temperature) systems may require special designs, which are not considered here.
- The liquids in the lines will isolate the secondary device from the temperatures of the primary flowing fluid.
- Over a short distance of 100 mm (4") to 200 mm (8"), the temperature difference can be considerable.

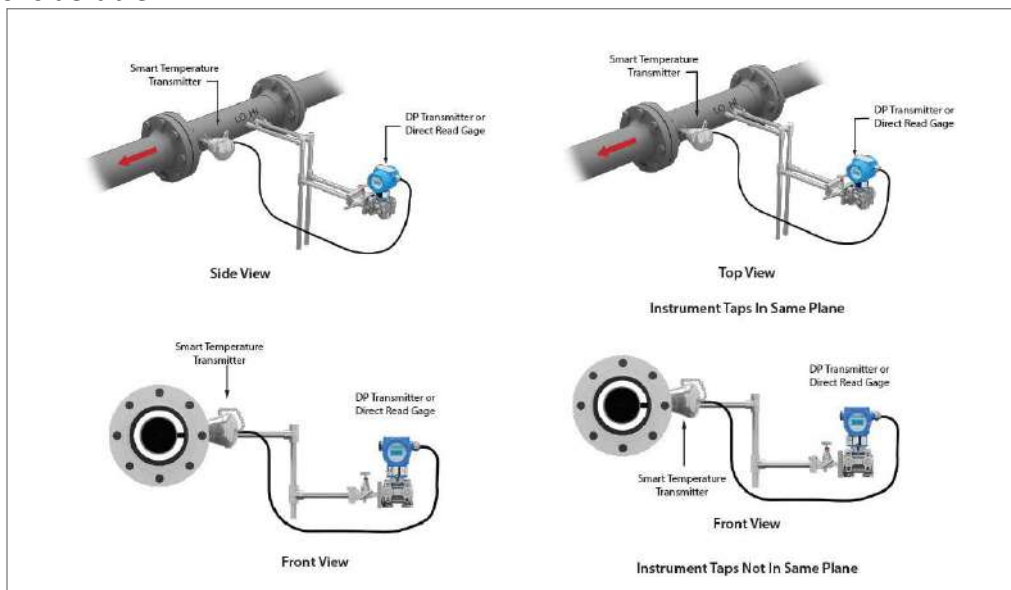

Fig 32: Horizontal Installation for Steam

3.4.2 Vertical Installation for Steam

- Wall Taps are mostly recommended for condensing vapors, preventing condensation from the buildup in the cone or evaporating and changing the DP.
- The impulse lines are shut down horizontally to a "T" at a minimum distance of 18" for saturated and superheated steam to reduce the temperature to below the saturation temperature.
- The "T" enables a plug to be installed at the top for the liquid filling to avoid overheating of the DP cell.

- The manifold block will be placed directly below at a distance to maintain the DP transmitter at a safe operating temperature.

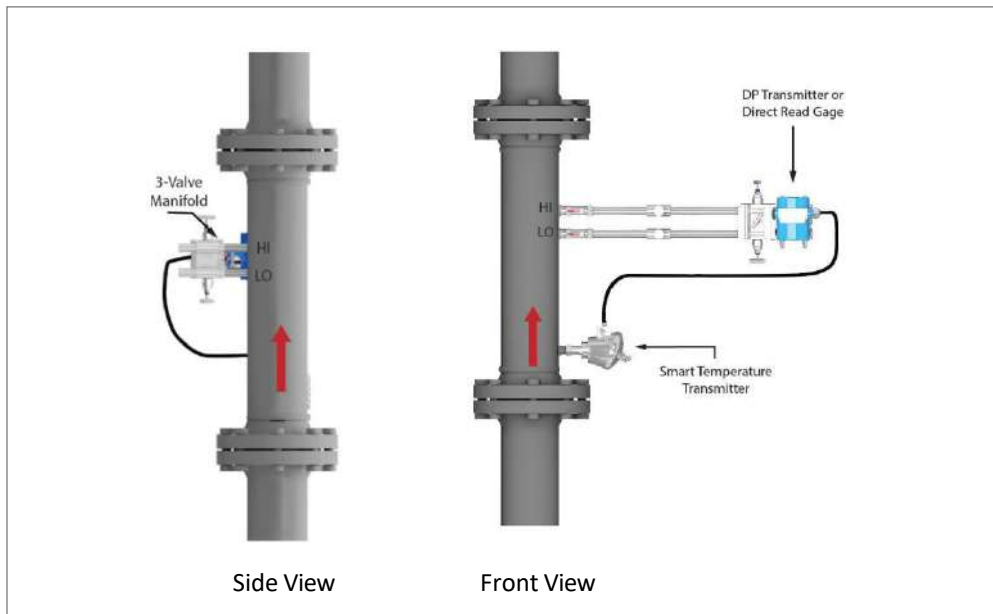
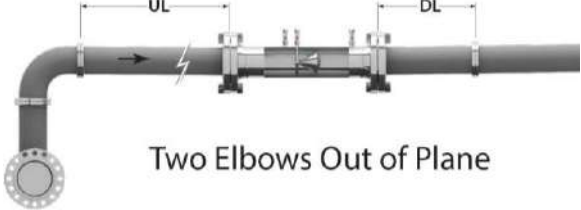

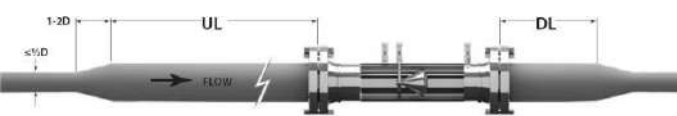



Fig 33: Vertical Installation for Steam

3.5 Installation for Upstream and Downstream

- In most of the flow elements, the proper operation and performance depend on unrestricted upstream and downstream piping length requirements.
- The fully developed symmetrical flow profile is achieved with relatively short upstream and downstream lengths.
- Therefore, it needs minimal upstream and downstream straight pipe runs. The Cone meter can be installed with 0 to 5D and 0 to 3D downstream.

*Note UL= Upstream DL= Downstream 0 = NR		0.4	0.5	0.6	0.7	0.8	
<p>Single Elbow</p>	UL	0	0	0	1D	1D	
	DL	0	0	0	1D	1D	
<p>Two Elbows In-Plane</p>	UL	0	0	0	1D	1D	
	DL	0	0	0	1D	1D	
		UL	0	0	0	1D	1D

 <p>Two Elbows Out of Plane</p>	DL	0	0	0	1D	1D
 <p>Pipe Reduction</p>	UL	1D	1D	1D	2D	2D
	DL	1D	1D	1D	2D	2D
 <p>Pipe Enlargement</p>	UL	1D	1D	1D	2D	2D
	DL	1D	1D	1D	2D	2D
 <p>Pipe with Tee</p>	UL	0	0	0	1D	1D
	DL	0	0	0	1D	1D
 <p>Gate/Globe Valve Fully Open/Partially Open</p>	UL	3D	3D	3D	4D	4D
	DL	0	0	0	1D	1D
	UL	3D	3D	3D	4D	4D
	DL	3D	3D	3D	4D	4D

4 Maintenance

- There should be no need for periodic maintenance or re-calibration if the meter is installed correctly.
- In extreme process conditions, periodically inspect the Tek-DP 1620A DP Cone Meter for any significant physical damage.
- Calibrate and maintain secondary and tertiary instrumentation according to the manufacturer's instructions.

5 Troubleshooting

This section provides troubleshooting techniques for most common operating problems shown in table 1.

Table 1: Troubleshooting Techniques

Symptoms	Area	Possible Problem or Solution
No Signal (0mA)	Transmitter	<ul style="list-style-type: none"> No Power to transmitter. Transmitter not wired correctly. Check continuity on wiring or loose connection.
Negative Signal (<0mA)	Transmitter	<ul style="list-style-type: none"> Transmitter wires are reversed.
Low signal (<4mA)	Tek-DP 1620A	<ul style="list-style-type: none"> Cone Meter is installed backwards, with gauge lines attached as marked. In this case, the high-pressure tap would be sensing a lower pressure than the low pressure tap. This negative DP would force the signal below 4mA.
	Gauge Line	<ul style="list-style-type: none"> Gauge lines are reversed. Transmitter shows more pressure on lower side than higher side. Check "H" and "L" marks on DP Cone Meter.
Zero Signal (4mA)	Tek-DP 1620A	<ul style="list-style-type: none"> Meter has been damaged. Remove meter and visually inspect. No flow in pipeline. Check other system locations to verify flow through the meter. The meter could be under pressure but still have no flow.
	Manifold	<ul style="list-style-type: none"> Manifold / gauge lines closed or blocked. Ensure valves and lines are open. If fluid is safe, open vent valves on transmitter to verify pressure in the gauge lines.
Wrong Signal High or Low	Tek-DP 1620A	<ul style="list-style-type: none"> Process conditions do not match actual conditions. Contact Tek-Trol or your sales representative to recalculate using the correct process conditions. Wrong meter. Verify serial numbers on meters to ensure correct specifications. Sometimes two meters are interchanged. Remember each DP Cone Meter has a unique flow coefficient.
	Gauge Lines	<ul style="list-style-type: none"> Foreign material trapped in gauge lines. Dirt and sediment can settle into the gauge lines. If the fluid is safe, vent the gauge lines and inspect for spurts of solids, gasses, or liquids (whichever should not be there). If the fluid is not safe, open the center manifold valve for several minutes under high DP. Close the

		<p>valve and compare the signal level to before readings.</p> <ul style="list-style-type: none"> In a horizontal, liquid application, install the meter with the taps on the sides of the pipe (3 or 9 o'clock) For a horizontal, gas application, install at top or sides of the pipe (12, 3, or 9 o'clock).
	Flow Computer	<ul style="list-style-type: none"> Flow calculations have an error. Use loop calibrator and apply 4, 12, and 20mA to computer / system. Each of these points should be correlate with the DP Cone Meter sizing information. Current output signal is read incorrectly. Apply a known current to the loop and read the raw signal in the computer. Most computers allow the user to see the mA signal directly.
Unsteady Signal	Tek-DP 1620A	<ul style="list-style-type: none"> Partially full pipe occurring (liquids only). Periods with a partially full pipe will cause wrong readings. See above for details.
Slow response time	Transmitter	Dampening.
Sudden change in readings	Tek-DP 1620A	<ul style="list-style-type: none"> Foreign object lodged in meter. This will increase the restriction of the meter and raise the DP. Remove the meter and visually inspect.
	Gauge Lines	<ul style="list-style-type: none"> There may be leakage in line.
Signal very High	Tek-DP 1620A	<ul style="list-style-type: none"> Meter body, near the pressure taps. If any arrow is not visible and the meter is large than 2", the flow direction can be determined by the location of the pressure taps. The pressure taps will be closer to the upstream side. On meters less than 2", the gauge lines will need to be removed. Look at the base of both pressure taps. One tap will be smooth at the base, the other will be mostly weld material. The smooth tap is on the upstream side. Flow is going in the opposite direction from what was expected. The assumption of flow direction is sometimes wrong. Verify with other system readings. With a meter measuring backward flow, the DP signal will be approximately 30% high. Partially full pipe (liquids only). A partially full pipe will cause the meter to read very high. This can happen even in pressurized systems. <ul style="list-style-type: none"> On horizontal pipes: If the fluid is safe, open a pressure tap on the top of the pipe. Air release will indicate partially full pipe.

		<ul style="list-style-type: none"> ○ On vertical pipes: Up flow will guarantee a full pipe. Down flow is difficult to diagnose if the pipe is full. ● Foreign object lodged in meter. This will increase the restriction of the meter and raise the DP. Remove the meter and visually inspect.
	Gauge Lines	<ul style="list-style-type: none"> ● Leak on low pressure gauge line. ● Perform a leak check from the meter to the transmitter.
	Transmitter	<ul style="list-style-type: none"> ● Leak on low pressure vent valve. Perform a leak check on valve. ● Zero point has shifted positively. This will cause errors more pronounced at the low end of the transmitter range. ● Verify by closing the manifold side valves and opening the center valve. The reading should go to zero (4mA). ● Recalibrate if necessary. DP span is set very low. ● Use pressure calibrator or handheld communicator to verify span point.
	Flow Computer	<ul style="list-style-type: none"> ● 4mA set to minimum flow. ● Our calculations assume that 4mA will be equal to zero flow. Sometimes 4mA is set to equal the minimum flow on the sizing page. ● This error will be zero at maximum flow and increase as the flow decreases. ● The amount of error will depend on the zero offset.
Signal Very Low	Manifold	<ul style="list-style-type: none"> ● Manifold is cross-vented. The center valve must be closed. ● To test, close the two side valves and watch the transmitter signal. ● If the signal goes to zero (4 ma), the center valve is not closed completely.
	Gauge lines	<ul style="list-style-type: none"> ● Leak on high pressure gauge line. ● Perform a leak check from the meter to the transmitter.

Customer Service & Support



TEK-TROL LLC reserves the right to change the designs and/or materials of its products without notice. The contents of this publication are the property of TEK-TROL LLC and cannot be reproduced by any other party without written permission. All rights reserved. Copyright © 2021 TEK-TROL LLC
TEK-TROL LLC
DOC # TEK/TPS/MNU/220817/1620A/01.1



www.tek-trol.com

Tek-Trol LLC

796 Tek Drive Crystal Lake,
IL 60014, USA



+1 847-857-6076



tekrol@tek-trol.com



www.tek-trol.com

Tek-Trol is a fully owned subsidiary of TEKMATIION LLC. We offer our customers a comprehensive range of products and solutions for process, power and oil & gas industries. Tek-Trol provides process measurement and control products for Flow, Level, Temperature & Pressure measurement, Control valves & Analyzer systems. We are present in 15 locations globally and are known for our knowledge, innovative solutions, reliable products and global presence.